

NC2200

SK-100181

AA/AAA NiMH/NiCD Battery Charger & Analyzer

Instruction Manual

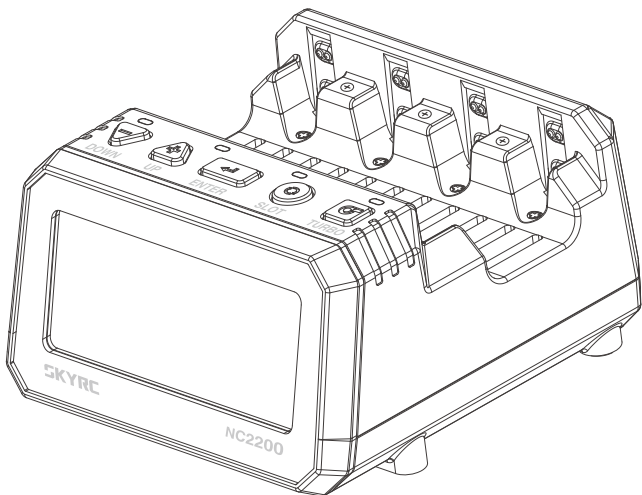

SKYRC

v2.1

TABLE OF CONTENTS

INTRODUCTION	1
IN THE BOX	1
PRECAUTIONS	3
FEATURES	3
SPECIFICATIONS	4
CHARGING CURRENT AUTOMATIC ADJUSTED	5
MANUALLY VIEW THE DISPLAYED INFO	5
BATTERY KNOWLEDGE	5
FIVE WORKING MODES	8
USING THE CHARGER	9
WORKING MODES	12
LED INDICATOR EXPLAINED	15
RESCUE BATTERIES	16
DISPLAYED INFORMATION & ICONS	16
SKYCHARGER APP OPERATION	18
LIABILITY EXCLUSION	21
WARRANTY AND SERVICE	21

INTRODUCTION

Congratulations on your choice of SkyRC NC2200 Charger & Analyzer!

This charger is specially designed for AA/AAA NiMH/NiCD Batteries. It has five working modes: Turbo(fast charge), Charge, Discharge, Refresh & Analyze, Break-in.

With four independent AA/AAA slots, NC2200 can charge up to 4 batteries at once, so you can quickly power your electronic devices. The working current can be set from 0.2A up to 2.2A based on different battery capacities.

With the wide-viewing VA screen, NC2200 displays current, capacity, internal resistance, voltage, elapsed time, and working mode at a glance. Meanwhile, the charging graph and firmware upgrading can be accessible with the SkyCharger app if you connect the optional Bluetooth Dongle.

*The optional Bluetooth Dongle(SK-600135)part is sold separately.

IN THE BOX

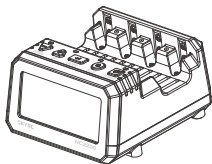

NC2200 Charger*1

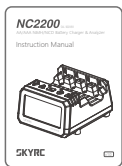

Instruction Manual*1

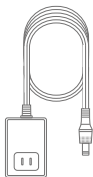

12V/2A
Power Adaptor*1

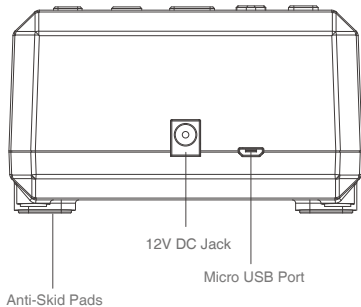
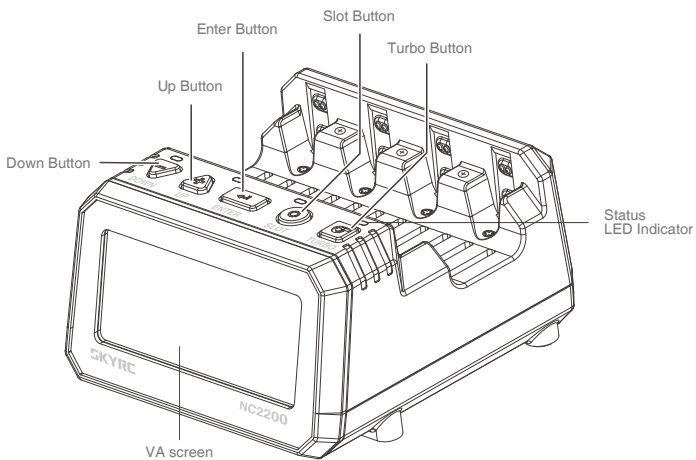

PRECAUTIONS

- Never charge batteries other than NiMH or NiCD. Please read the battery's manual to ensure it can accept the programmed charge/discharge rates.
- Never expose the unit to rain or moisture to avoid fire.
- Never use the charger if it appears damaged.
- Do not place the battery with a positive terminal facing the top. Wrong polarity may cause fire or explosion.
- Do not allow the unit to expose to direct sunlight. Operate in a well-ventilated area. Do not place the charger on the carpet.
- Never allow the battery terminals to become shorted.
- Please use the standard AC adaptor included in the package.
- The batteries may become hot during charging/discharging(especially at a high chosen current).
- Please use caution while removing batteries after charging/discharging.
- Remove all the batteries while not in use.

FEATURES

- Four independent slots allow charging four cells simultaneously.
- Four LED indicators make working status intuitive.
- Easy operation with five buttons.
- Five working modes of Turbo Charge, Charge, Discharge, Refresh & Analyze, Break-In.
- TURBO charge available with a charging rate of up to 2.2A for each slot.

- Auto-start within ten seconds once batteries are inserted.
- Adjust current automatically based on the battery resistance detected.
- Ez-setup: long-press to apply the same setting to all slots after setting for one slot.
- The wide-viewing VA screen enables super-high static contrast ratios for impressive stunning visioning.
- Intuitive interface with independent display for each slot.
- All information at a glance: Rate, Capacity, Elapsed time, Internal Resistance, Voltage, and Working mode.
- The charging graph and firmware upgrading can be accessible with the SkyCharger app if you connect the optional Bluetooth Dongle.

*The optional Bluetooth Dongle(SK-600135) is sold separately.

SPECIFICATIONS

- Battery Type: NiMH/NiCD
- Battery Size: AA/AAA
- Charge Rate: 0.2-2.2A w/ increments of 0.1A
- Discharge Rate: 0.1-1.0A w/ increments of 0.1A
- Discharge Termination Voltage: 0.9V
- Supported Capacity: 500-3200mAh
- Capacity Protection: 3200mAh
- Input Power: DC 12V/2.0A
- $-\Delta V$: 5mV
- Trickle Current: 50mA
- Weight: 370g
- Size: 112.1*108*62 mm

CHARGING CURRENT AUTOMATIC ADJUSTED



The internal resistance of the battery usually increases as it is used. When the battery is used for a long time, its internal resistance will increase. The internal resistance consumes part of the electric energy when charging and causes the battery to heat up at the same time.

We deploy an innovative FlexiPulse algorithm for internal resistance detection in this charger. Once a high internal resistance is detected, the charge current will automatically decrease to reduce the overall heating and protect the battery.

Note: Please use the Refresh & Analyze mode when determining the battery capacity.

Battery Internal Resistance	Charge Rate
Great than 20mΩ while less than or equal to 40mΩ	Limit to 1.5A
Great than 40mΩ	Turbo charge stops
Great than 40mΩ while less than or equal to 60mΩ	Limit to 800mA
Great than 60mΩ	Limit to 400mA

MANUALLY VIEW THE DISPLAYED INFO

When multiple slots are working, the charger allows switching between slots by pressing the  button. Click the  button to switch and view the specific slot's info.

BATTERY KNOWLEDGE

What is the Meaning of “mAh” on Rechargeable Batteries?

mAh means milliamp Hour and is a unit that measures (electric) power over time. It is commonly used to measure the energy capacity of a battery. In general, the more **mAh** and the longer the battery capacity or battery life.

Battery Capacity **mAh** (milliampere/hour) = discharge (milliampere) x discharging time (hour)

For example, if you insert 2400mAh battery into an appliance which consumes 50 milliampere current continuously, the operating time of the appliance will be around 48 hours.

What is "C" Charge/Discharge Rate

The battery "C" Rating is the measurement of current at which a battery is charged or discharged. "C" stands for the battery capacity, and the number preceding it is the fraction of the battery capacity. For example, 0.3C means 0.3 times the capacity for the battery. For a 2400mAh battery, 0.3C would be $0.3 \times 2400\text{mAh} = 720\text{mA}$.

Choose the Right Charge & Discharge Rate

It is not recommended to charge at a rate lower than 0.3C and higher than 1.0C. Charging too slow may affect the charger termination properly. Charging too fast may cause the battery to overheat, and shorten its lifespan.

Generally speaking, a smaller charging rate can prolong the battery lifespan while charging time will be longer. A larger charging rate makes charging fast but with the battery heat-up, which will shorten its lifespan.

It is not recommended to use a discharge rate above 1.0C.

Charge/Discharge Rate Reference

AAA Batteries

Battery Capacity(mAh)	Charge Rate(mA)	Discharge Rate(mA)
700	300	100
800	400	200
900	400	200
1000	500	200
1100	500	200
1200	600	300

AA Batteries

Battery Capacity(mAh)	Charge Rate(mA)	Discharge Rate(mA)
1800	1800	400
2200	2000	500
2400	2000	600
2600	2000	600
2700	2000	600

Battery Matching

Most electronic devices usually require two or more batteries to be used together. In this circumstance, the overall performance of power will be limited by the worst battery.

In other words, the poorly performing battery will affect the operating time of the device. We can understand battery matching as group batteries with similar actual capacity.

Grouping batteries by similar capacity will maximize the battery series' efficiency.

You can group batteries easily in the Refresh & Analyze mode!

Battery Formatting

New batteries and those stored for more than three months become chemically deactivated. The battery formatting refers to activating the battery with a small charge and discharge rate in a charge-discharge-charge sequence, this can be achieved through the Break-in mode.

In some circumstances, this process may need to be repeated two to three times.

FIVE WORKING MODES

The charger comes with five working modes, each of which will be used under the different situations below.

Mode	Scenario
TURBO CHARGE	Fast charge with a large current of 2.2A for the batteries that are needed urgently.
CHARGE	Charge the battery with a programmable charge rate.
DISCHARGE	Discharge the battery with a programmable discharge rate.
REFRESH & ANALYZE	Refresh and analyze mode is used to determine the battery's performance based on the actual capacity it can hold. It's applicable for batteries stored for more than two weeks and less than three months, or for batteries that are not performing well.
BREAK-IN	Applicable for new batteries and those stored for more than three months. The BREAK-IN mode is to activate the battery with a small charge and discharge rate in a charge-discharge-charge sequence.

USING THE CHARGER

1, Ensure there are no batteries inside the slots before powering up. Plug the DC jack of the power adaptor into the charger and plug the adaptor to the wall socket.

2, Insert batteries.

Note: Always insert the Negative(-) terminal FIRST as shown in the diagram. The setting interface will pop up for each slot based on the inserting sequence if more than one battery is inserted at a time.

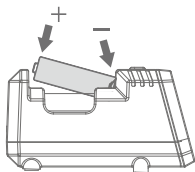

Inserting AA Batteries

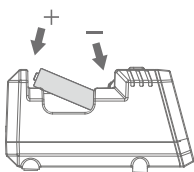



Inserting AAA Batteries

3, Program and start

Autostart: The charger will start charging automatically with the CHARGE mode and 1000mA of charge rate as default if no operation within ten seconds after the battery is inserted. NC2200 will start working automatically to the last remembered setting if the charger worked once and its power uninterrupted.

Discharge setting: (take the DISCHARGE MODE for example)

- Short-press the  or  buttons to select the desired mode when "CHARGE" is blinking, click the  button to confirm.

- Short-press the  or  buttons to select the desired discharge rate when "SET DISCHARGE RATE" is displayed and click the  button to start discharging.

Note: If you plan to apply this setting to all the rest slots, PRESS & HOLD the  button for two seconds to start charging.

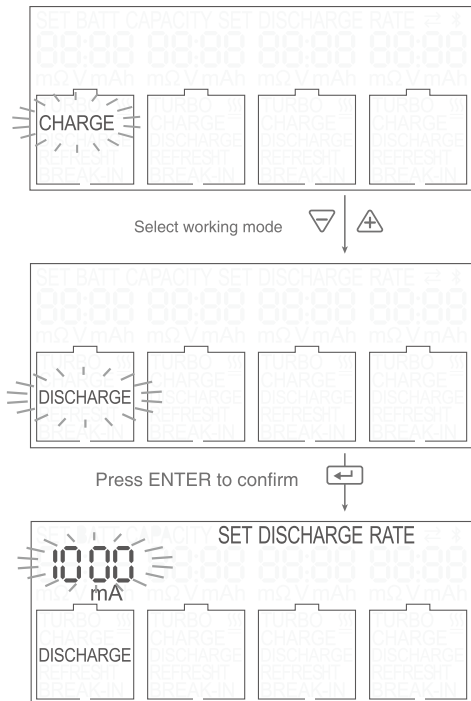

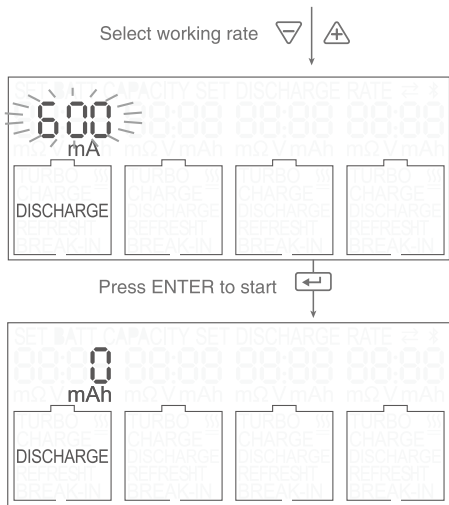

4, The LED indicator will be solid red during the charging process.

Note: During charging or discharging, the batteries' heating-up is normal. An audible faint may also occur.





5, The LED indicator will be solid green after charging is completed.

WORKING MODES

CHARGE MODE

- Please refer to the BATTERY KNOWLEDGE on page 6 to select an appropriate rate to charge the battery by the selected charge rate.
- Useful when the battery needs to be recharged without determining the capacity. Applicable for charging the batteries in a good performance and continuous use.

To start the CHARGE mode.

- 1, Insert the batteries into the slots.
- 2, Short-press the  or  buttons to enter the CHARGE mode when "CHARGE" is blinking
- 3, Short-press the  or  buttons to select the appropriate charge rate when "SET CHARGE RATE" is displayed and click the  button to start charging.

Note: If you would like to apply this setting to all the rest slots, PRESS and HOLD the  button for two seconds to start charging.

- 4, The LED indicator will be solid red during the charging process.
- 5, The LED indicator will be solid green after charging is completed.

TURBO CHARGE MODE

- To start the TURBO CHARGE mode for those battery slots being in the charging process.

Note: This mode assumes batteries must perform very well. The charger will detect the battery resistance automatically under TURBO mode. If the battery resistance is more than 40mΩ, the value and LED red indicator will be blinking, and the charger will stop working to protect the battery.

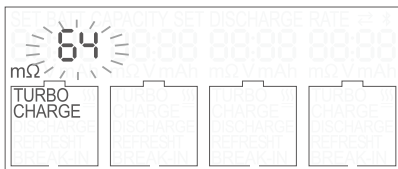







To start the TURBO CHARGE mode

- 1, Press and hold the  button for five seconds to start the TURBO mode for those slots being in the charging process.
- 2, The LED indicator will be solid red during the charging process.
- 3, The LED indicator will be solid green once charging is completed.

DISCHARGE MODE

- Please refer to BATTERY KNOWLEDGE on page 6 to select an appropriate rate to discharge the batteries.

To start the DISCHARGE mode.

- 1, Insert the batteries into the slots.
- 2, Short-press the  or  buttons to select the DISCHARGE mode when "CHARGE" is blinking and click the  button to confirm.
- 3, Short-press the  or  buttons to select the appropriate discharge rate when "SET DISCHARGE RATE" is displayed and click the  button to start discharging.

Note: If you would like to apply this setting to all the rest slots, PRESS and HOLD the  button for two seconds to start discharging.









- 4, The LED indicator will be solid red during discharging.
- 5, The LED indicator will be solid green after discharging is completed.

REFRESH & ANALYZE MODE

- To determine the battery performance based on the capacity amount it can hold after a charge, discharge, and charge cycle, please refer to the BATTERY KNOWLEDGE on page 6 to select an appropriate rate.

- The actual amount charged in the last cycle can be viewed on the charger.
- Applicable to those batteries not performing well and determine the actual capacity of the battery.

To start the REFRESH & ANALYZE mode.

- 1, Insert the batteries into the slots.
- 2, Short-press the  or  buttons to select the REFRESH & ANALYZE mode when "CHARGE" is blinking, and click the  button to confirm.
- 3, Short-press the  or  buttons to select the appropriate charge rate when "SET CHARGE RATE" is displayed and click the  button to start charging.
- 4, Short-press the  or  buttons to select the appropriate discharge rate when "SET DISCHARGE RATE" is displayed and click the  button to start discharging.

Note: If you would like to apply this setting to all the rest slots, PRESS and HOLD the  button for two seconds to charge or discharge.

The process of the REFRESH & ANALYZE mode are as follows





- Charge and then rest for 1 hour.
 - Discharge and then rest for 1 hour.
 - Charge until fully charged.
- 5, The LED indicator will be solid red during working.
 - 6, The LED indicator will be solid green when the process is completed.

BREAK-IN MODE

- Charge the batteries at 0.1C(0.1*battery capacity) for 16 hours and rest for 1 hour. Then, fully discharge the batteries at 0.2C and rest for 1 hour again. Finally, charge the batteries at 0.1C for 16 hours again.

- This process is also well-known as BATTERY FORMATTING and applicable to the batteries that cannot be rescued by the REFRESH & ANALYZE mode.
- The mode requires 39-45 hours to complete.

To start the BREAK-IN mode.

- 1, Insert the batteries into the slots.
- 2, Short-press the  or  buttons to select the BREAK-IN mode when "CHARGE" is blinking, click the  button to confirm.
- 3, Short-press the  or  buttons to select the battery capacity to determine the charge and discharge rate.

When "SET BATT CAPACITY" is displayed and click the  button to start BREAK-IN.

Note: If you would like to apply the setting to all the rest slots, please press and hold the  button for two seconds instead of a short-press.

- 4, The LED indicator will be solid red during working.
- 5, The LED indicator will be solid green after the process is completed.

LED INDICATOR EXPLAINED

LED Indicator	Explanation
Off	Stand by
Solid Red	Batteries inserted or charging
Solid Green	Charging complete
Blinking Red	The battery resistance is more than 40mΩ, Turbo Mode terminates.

RESCUE BATTERIES

If the batteries are still not performing well after trying all the modes as in the manual, refer to the battery rescue steps below:

- 1, Use the REFRESH & ANALYZE mode once to three times.
- 2, Change to BREAK-IN mode if the capacity is still low.
- 3, If the second steps can improve the battery capacity by more than 10%, please try BREAK-IN mode once to three times again. If there are no significant improvements and the actual battery capacity is less than 60% of its rated capacity. The battery would probably be at the end of its life and needs to be replaced.

DISPLAYED INFORMATION

The charger will display rate, capacity, internal resistance, voltage, working mode, and elapsed time.



Charge / Discharge Rate

This is the value above "mA" which means the charge or discharge rate.

Note: The value will be slightly changed based on the selected rate due to the pulse charging.



Capacity

This is the value above "mAh" which means the total charged or discharged capacity.



Elapsed Time

This is the time elapsed for a particular routine such as charging, discharging, or rest in the program.



Battery Voltage

This is the value above "V" which means the battery voltage. If the battery is measured with a multimeter during charging, the reading may differ from what the charger shows. The reason is the multimeter cannot accurately measure the voltage during charging or discharging.



Battery Internal Resistance

This is the value above "mΩ" which means the battery internal resistance.



Overheat

When the internal temperature is more than 80°C(176°F),  icon will show to indicate that the temperature is too high. Please stop the charger and resume until it cools off.



Bluetooth

When the charger is connected with the app,  icon will be displayed on the screen indicating connection success.

SKYCHARGER APP OPERATION

The charging graph and firmware upgrading can be accessible with the SkyCharger app if you connect the optional Bluetooth Dongle.

*The optional Bluetooth Dongle(SK-600135)part is sold separately.

Bluetooth Dongle is based on the BLE(Bluetooth Low Energy) that it can only be accessible by the SkyCharger app!

Please be reminded: NEVER try to connect Bluetooth Dongle via Phone's>Setting>Bluetooth!

Just make sure your phone's Bluetooth is enabled, launch the SkyCharger app, search and connect Bluetooth Dongle inside the app.

To use the app

- 1, Make sure there are no batteries inserted in the battery slots before connecting the power. Connect the DC plug of the power adaptor to the charger and plug the power adaptor into the wall socket.
- 2, Insert AA or AAA batteries.
- 3, Start charging after programmed.
- 4, Scan the QR code below to download the SkyCharger app.



SkyCharger app



- Enable Bluetooth on your mobile device.



Launch the SkyCharger app.



Select the device found.



View the charging info.



Click details to view the charging graph.



Click the battery icon to switch between slots to view the charging graph.



The graph can be zoomed in and out.



Click back for details page.



Click Version to check if any newer firmware; if yes, click OK to upgrade.



LIABILITY EXCLUSION

This charger is designed and approved exclusively for use with the types of the battery stated in this Instruction Manual. SkyRC accepts no liability of any kind if the charger is used for any purpose other than that stated. We are unable to ensure that you follow the instructions supplied with the charger, and we have no control over the methods you employ for using, operating and maintaining the device. For this reason we are obliged to deny all liability for loss, damage or costs which are incurred due to the incompetent or incorrect use and operation of our products, or which are connected with such operation in any way. Unless otherwise prescribed by law, our obligation to pay compensation, regardless of the legal argument employed, is limited to the invoice value of those SkyRC products that were immediately and directly involved in the event in which the damage occurred.

WARRANTY AND SERVICE

We guarantee this product to be free of manufacturing and assembly defects for one year from the time of purchase. The warranty only applies to material or operational defects, which are present at the time of purchase. During that period, we will repair or replace free of service charge for products deemed defective due to those causes. This warranty is not valid for any damage or subsequent damage arising as a result of misuse, modification, or as a result of failure to observe the procedures outlined in this manual.

Note

The warranty service is valid in China only.

If you need warranty service overseas, please contact your dealer in the first instance, who is responsible for processing guarantee claims overseas. Due to high shipping cost, complicated custom clearance procedures to send back to China.

Please understand SkyRC can't provide warranty service to overseas end users directly. If you have any questions which are not mentioned in the manual, please feel free to send email to info@skycrc.com

SKYRC

This content is subject to change.

**Latest version can be downloaded
from www.skyrc.com**

If you have any question about this document, please contact
SkyRC by sending a message to info@skyrc.com
All Rights Reserved.

Manufactured by
SKYRC TECHNOLOGY CO., LTD.
www.skyrc.com

© 2021 SkyRC Technology Co., Ltd. All Rights Reserved.
[Version 2.1]



7504-1510-02