

INSTRUCTION MANUAL

TX58025

SK-600108-02

SKYRC

INTRODUCTION

SkyRC S-WAVE's TX58025 FPV video transmitter (Tx) is used for sending video signals from a camera mounted inside quadcopter to a 5.8GHz receiver (Rx) on the ground. The medium 25mW transmission power means more pilots can fly together without overpowering each other on close frequencies. TX58025 use single button, LEDs interface to select and display band/frequency. Five bands with a total of 40 frequencies in the 5.8GHz spectrum can be selected by user. It also comes a clean pre-wired harness. The Tx includes a 5V output to power FPV cameras and an on-board microphone to transmit audio to your receiver.

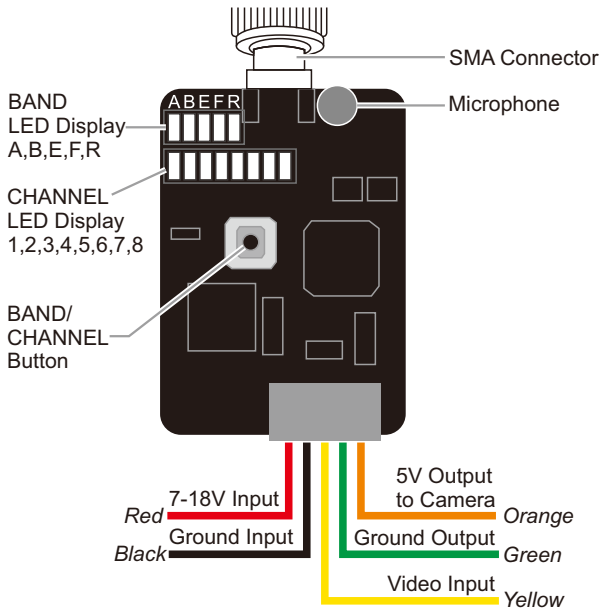

CONNECT TO BATTERY AND CAMERA

Input Power Connection

Connect the red and black wire to the battery. Make sure polarities match! Do NOT exceed the acceptable input voltage range of 7.4 - 18 volts, which can be achieved with a 2S-4S lithium-polymer(LiPo) battery.

Camera Connection

Connect the yellow, green and orange wire to the camera's video signal output.
Yellow wire to video signal output
Green wire to ground
Orange wire to power input

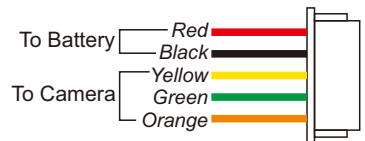

SELECT THE BAND/CHANNEL

One button and LEDs for frequency selection method is easy and intuitive.

Frequency Selection: Single push to change frequency, push and hold for 2 seconds to change band.

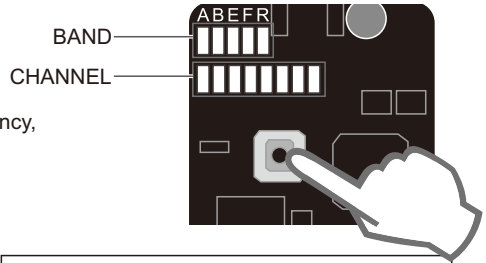

BAND A



BAND B



BAND E



BAND F



BAND R



FPV REGULATORY NOTICE

Use and operation of this type of product in the USA and many other countries may require a license and some countries may forbid its use entirely. In the USA, you need a "HAM" amateur radio license. Use of this product without having a HAM license is forbidden. It is your responsibility to ensure that the use of this product meets the requirements imposed by your government's rules and regulations for RF devices.

SPECIFICATION

- 40 channels: Covers 5 Bands
- Transmitter frequency: 5645-5945GHz
- Power output: 25mW
- Operating Voltage: 7-18V
- Operating Temperature: -10 +50 C
- Video Input Impedance: 75 Ohm
- Antenna Connector: SMA Female Connector
- Video Format: NTSC/PAL
- Audio: Includes on board microphone
- Provides 5V power output for FPV cameras
- Transmitting distance > 100m (open area)
- SMA Antenna connector
- Dimensions: 32.8x22x11.8mm (not including SMA adapter)
- Weight: 11.5g (without antenna)



Manufactured by
SKYRC TECHNOLOGY CO., LTD.
www.skyrc.com 7504-0805-01