

B6 *nano duo*

Professional AC Balance Charger / Discharger

Instruction Manual

[Version 1.00]

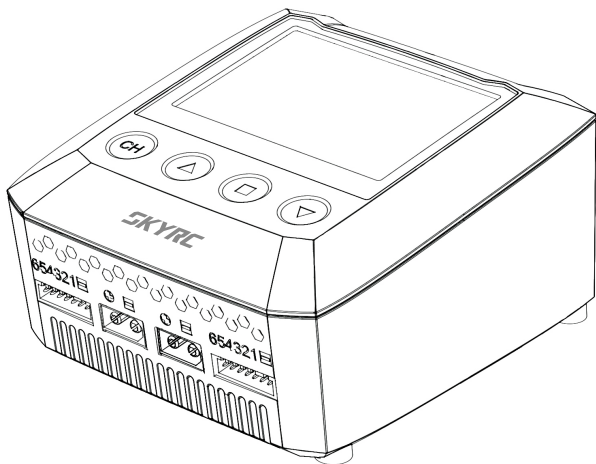

SKYRC

TABLE OF CONTENTS

INTRODUCTION.....	01
SPECIAL FEATURES	03
WARNING AND SAFETY NOTES	05
OPERATING PROGRAM.....	08
WARNING AND ERROR MESSAGE.....	13
CONTROLLING THE CHARGER USING THE APP.....	14
SPECIFICATION.....	19
REGULATORY INFORMATION.....	20
COMMONLY USED TERMS	21
WARRANTY AND SERVICE.....	22

Congratulations on your choice of SkyRC B6 nano duo. The operation and UI has been optimized to be hassle-free for basic usage. Being app-enabled, the user experience can be largely expanded, more features and advanced settings are provided within the free app.

Multiple safety protections are implemented, such as, reverse polarity protection, charging time limit, charging capacity limit.

The operation of a multi-chemistry battery charger does require certain knowledge on the part of the user. Please BE SURE to read these INSTRUCTIONS, WARNING and SAFETY NOTES before you use the charger. It can be dangerous, fire or explosion, if misoperation happens.

We hope you have years of pleasure and success with your new battery Charger.

THE SET CONTAINS

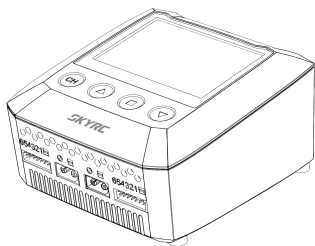

SkyRC B6 nano duo Charger

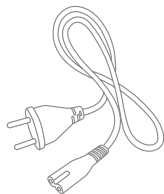

AC Power Cord

INTRODUCTION

Please read this entire operating manual completely and attentively before using this product, as it covers a wide range of information on operating and safety. Or please do use this product in company with a specialist!

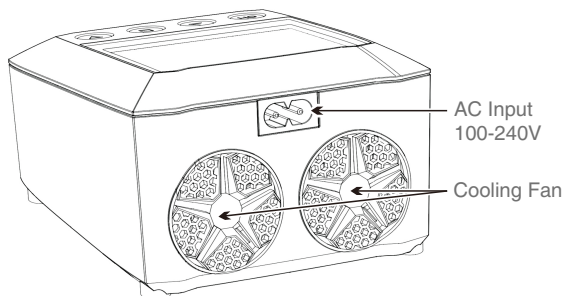
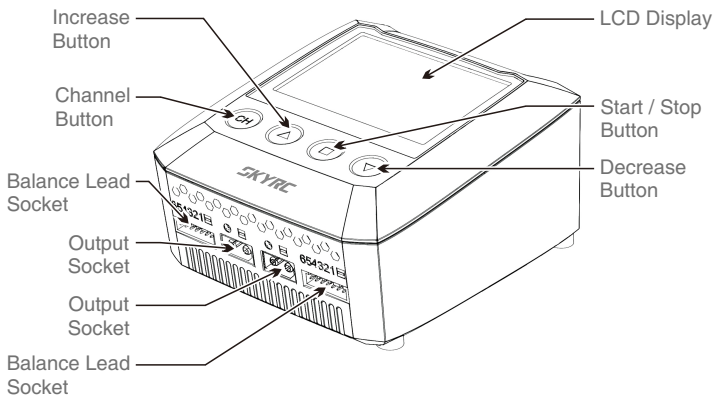

Scan to Go

The innovative Bluetooth Smart technology makes controlling your charger a breeze with your smart phones. Create a QR code with smart phone control APP or SkyRC website, print and paste it on the battery, scan the QR code and the charger will start working.

Smart Phone Control (both iOS and Android)

The free SkyCharger App unleashes tons of features and advanced settings, which tremendously expands the user experience of B6 nano duo.

Twin-channel Charger

SKYRC B6 nano duo allows you to plug 2 batteries into one charger simultaneously, and it will intelligently and automatically charge 2 batteries at once to their maximum capacity. To top of it, the batteries being charged do not even need to have the same configuration. You can connect different chemistry(LiPo/LiFe/Lilon/LiHV/NiMH/NiCd/Pb)batteries into any of the charging ports.

Internal Independent Lithium Battery Balancer

With the balance lead connected, B6 nano duo will balance your lithium batteries while charging or discharging.

Adaptable to Various Types of Batteries

B6 nano duo is adaptable to various types of batteries, such as LiPo, NiMH, Pb and the latest LiHV batteries.

Fast and Storage Mode for Lithium Battery

With highly optimized software, the preset modes can meet various charging purposes, 'fast' charge reduces the duration of charging, whereas 'storage' controls the terminal voltage of your battery to the best state for storing while protects its lifespan.

Delta-peak Sensitivity for NiMH/NiCd

Delta-peak sensitivity for NiMH/NiCd battery: the automatic charge termination program based on the principle of the Delta-peak voltage detection. When the battery's voltage exceeds the threshold, the process will be terminated automatically.

Cyclic Charging/ Discharging

1 to 5 cyclic and continuous process of charge> discharge or discharge> charge is operable for battery refreshing and balancing to stimulate the battery's activity.

Capacity Limit*

The charging capacity is always calculated as the charging current multiplied by time. If the charging capacity exceeds the limit, the process will be terminated automatically when you set the maximum value.

Processing Time Limit*

You can limit the maximum process time to avoid any possible defect.

Terminal Voltage Control (TVC)*

Experienced users or experts can set charge or discharge terminal voltage according to their needs.

**This feature is available in the SkyCharger App only.*

WARNING AND SAFETY NOTES

These warnings and safety notes are particularly important. Please follow the instructions for maximum safety; otherwise the charger and the battery can be damaged or at worst it can cause a fire.

- ⚠ Never leave the charger unattended when it is connected to its power supply. If any malfunction is found, **TERMINATE THE PROCESS AT ONCE** and refer to the operation manual.
- ⚠ Keep the charger well away from dust, damp, rain, heat, direct sunshine and vibration. Never drop it.
- ⚠ The allowable AC input voltage is 100~240V AC
- ⚠ This charger and the battery should be put on a heat-resistant, noninflammable and nonconductive surface. Never place them on a car seat, carpet or similar. Keep all the inflammable volatile materials away from operating area.
- ⚠ Make sure you know the specifications of the battery to be charged or discharged to ensure it meets the requirements of this charger. If the program is set up incorrectly, the battery and charger may be damaged. It can cause fire or explosion due to overcharging.

Standard Battery Parameters

	LiPo	Lilon	LiFe	LiHV	NiCd	NiMH	Pb
Nominal Voltage	3.7V/cell	3.6V/cell	3.3V/cell	3.7V/cell	1.2V/cell	1.2V/cell	2.0V/cell
Max Charge Voltage	4.2V/cell	4.1V/cell	3.6V/cell	4.35V/cell	1.5V/cell	1.5V/cell	2.4V/cell
Storage Voltage	3.8V/cell	3.7V/cell	3.3V/cell	3.85V/cell	n/a	n/a	n/a
Allowable Fast Charge	≦1C	≦1C	≦4C	≦1C	1C-2C	1C-2C	≦0.4C
Min. Discharge Voltage	3.0-3.3V/cell	2.9-3.2V/cell	2.6-2.9V/cell	3.1-3.4V/cell	0.1-1.1V/cell	0.1-1.1V/cell	1.8V/cell

Be very careful to choose the correct voltage for different types of battery otherwise you may cause damage to the batteries. Incorrect settings could cause the cells to fire or explode.

⚠ Never attempt to charge or discharge the following types of batteries.

A battery pack which consists of different types of cells (including different manufacturers)

A battery that is already fully charged or just slightly discharged.

Non-rechargeable batteries (Explosion hazard).

Batteries that require a different charge technique from NiCd, NiMh, LiPo or Gel cell (Pb, Lead acid).

A faulty or damaged battery.

A battery fitted with an integral charge circuit or a protection circuit.

Batteries installed in a device or which are electrically linked to other components.

Batteries that are not expressly stated by the manufacturer to be suitable for the currents the charger delivers during the charge process.

⚠ Please bear in mind the following points before commencing charging:

Did you select the appropriate program suitable for the type of battery you are charging?

Did you set up adequate current for charging or discharging?

Have you checked the battery voltage? Lithium battery packs can be wired in parallel and in series, i.e. a 2 cell pack can be 3.7V (in parallel) or 7.4V (in series).

Have you checked that all connections are firm and secure?

Make sure there are no intermittent contacts at any point in the circuit.

⚠ Charging

During charge process, a specific quantity of electrical energy is fed into the battery. The charge quantity is calculated by multiplying charge current by charge time. The maximum permissible charge current varies depending on the battery type or its performance, and can be found in the information by the battery manufacturer. Only batteries that are expressly stated to be capable of quick-charge are allowed to be charged at rates higher than the standard charge current.

Connect the battery to the terminal of the charger: red is positive and black is negative. Due to the difference between resistance of cable and connector, the charger can not detect resistance of the battery pack, the essential requirement for the charger to work properly is that the charge lead should be of adequate conductor cross-section, and high quality connectors which are normally gold-plated should be fitted to both ends.

Always refer to the manual by battery manufacturer about charging methods, recommended charging current and charging time. Especially, the lithium battery should be charged according the charging instruction provided by the manufacturer strictly.

Attention should be paid to the connection of lithium battery especially.

Do not attempt to disassemble the battery pack arbitrarily.

Please get highlighted that lithium battery packs can be wired in parallel and in series. In the parallel connection, the battery's capacity is calculated by multiplying single battery capacity by the number of cells with total voltage stay the same. The voltages imbalance may cause fire or explosion. Lithium battery is recommended to charge in series.

Discharging

The main purpose of discharging is to clean residual capacity of the battery, or to reduce the battery voltage to a defined level. The same attention should be paid to the discharging process as charging. The final discharge voltage should be set up correctly to avoid deep-discharging. Lithium battery can not be discharged to lower than the minimum voltage, or it will cause a rapid loss of capacity or a total failure. Generally, lithium battery doesn't need to be discharged. Please pay attention to the minimum voltage of lithium battery to protect the battery.

Some rechargeable batteries have a memory effect. If they are partly used and recharged before the whole charge is accomplished, they remember this and will only use that part of their capacity next time. This is a memory effect. It is said that NiCd and NiMH batteries are suffering from memory effect. NiCd has more memory effect than NiMH.

1. Connect the charger to the wall socket.

Insert the AC Power cord into the charger and insert the other end of the power cord into a wall socket(100-240V).

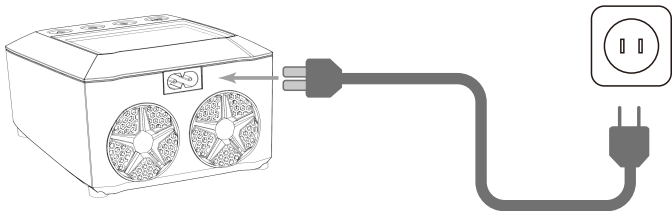

2. Insert the battery to the charger

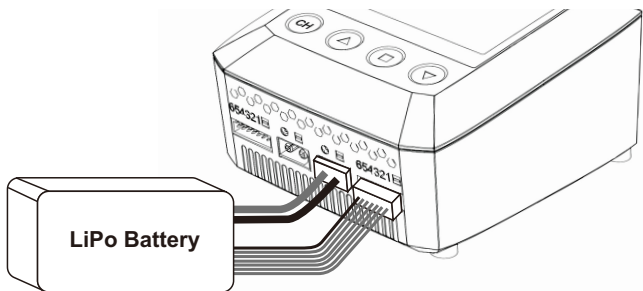

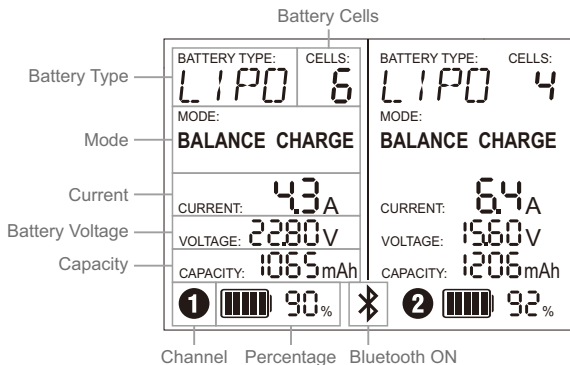

Channel: select the channel of the battery to be processed

Battery Type: select the chemistry of the battery to be processed.

Cells: select how many cells of the battery to be processed.

Mode: select which process the charger will run.

Current: select the current of charge/discharge process.

Voltage: display the voltage of the connected battery.

Capacity: calculate the electric charge transferred.

Percentage: display the remaining capacity of the connected battery.

Bluetooth: indicate the charger is connected with mobile device.

(Following steps are taking left channel screen for example)

3. Channel Switch

Press **CH** button, the parameter in the selected channel will blink.

Press **CH** button to switch the charger from Channel 1 to 2 or Channel 2 to 1.

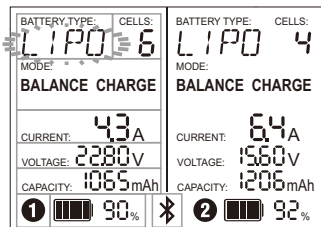

4. Battery Type Setting

Press  button, the battery type will be blinking.

Then Press  or  button to select the correct battery type.

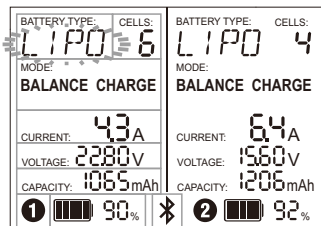

5. Battery Cells Setting

Press  button, the battery cells will be blinking.

Then Press  or  button to select the correct battery cells.

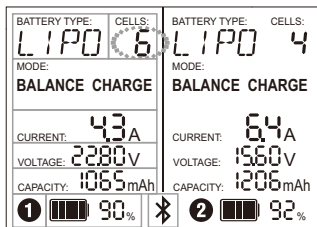

6. Charging Mode Setting

Press  button, the mode will be blinking.

Then Press  or  button to select the charging mode.

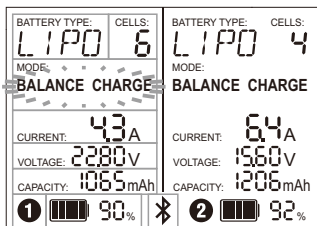

7. Charge Current Setting

Press  button, the current will be blinking.

Then Press  or  button to select the charge current.

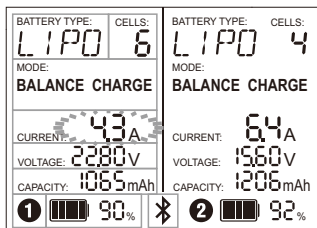

8. Program Start

Press and hold  button for 3 seconds to start the program.

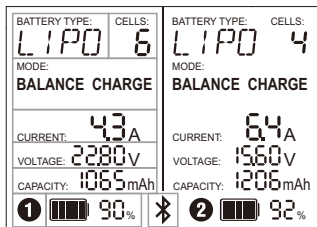

9. Program Stop

During the charging process, press  button to stop the charging process.

10. Program Complete

When the charging process finished, and 5 beeps audible sound will be heard.

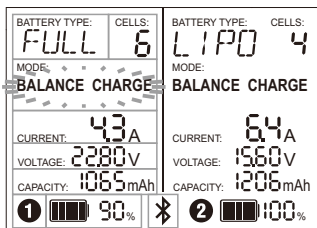

Charging Program

Depends on different battery type, the operation programs are different.

Batt Type	Operation Program	Description
LiPo Lilon LiFe LiHV	CHARGE	This charging mode is for charging LiPo/LiFe/Lilon/LiHV battery in normal mode.
	DISCHARGE	This mode is for discharging LiPo/LiFe/Lilon/LiHV battery.
	STORAGE	This program is for charging or discharging lithium battery which will not be used for long time.
	FAST CHG	The charging capacity may be a bit smaller than normal charging but the process time will be reduced.
	BAL CHARGE	This mode is for balancing the voltage of lithium-polymer battery cells while charging.
NiMH NiCd	CHARGE	The charger will charge NiMH and NiCd batteries using the charge current set by the user.
	DISCHARGE	This mode is for discharging NiMH/NiCd battery.
	CYCLE	1 to 5 cyclic and continuous process of charge>discharge or discharge>charge is operable for battery refreshing and balancing to stimulate the battery's activity.
Pb	CHARGE	This mode is for charging Pb battery.
	DISCHARGE	This mode is for discharging Pb battery.

WARNING AND ERROR MESSAGE

In case of an error the screen will display the cause of error and emit 10 beeps audible sound.



No battery attached.



The cell number is wrong.



The battery voltage is higher than the maximum voltage which the user sets when charging in balance mode.



Balance port voltage error.



Battery is full.



Incorrect polarity connected.



The internal temperature of the unit goes too high.



DC Output of Internal AC adaptor too low.



DC Output of Internal AC adaptor too high.



The battery capacity is more than the maximum capacity which the user sets.



The charging time is longer than the maximum charging time which the user sets.

The Bluetooth 4.0 connectivity allows the user to control and monitor the B6 nano duo comfortably through an app on a portable device such as smart phone, iPad, or iPhone. The iOS app can be downloaded from iTunes store, the Android app from Google Play Store. Operation of the app is self-explanatory and the same on iOS and on Android. Explicit pairing is not required; after download and installation just activate Bluetooth on your mobile device and launch the App. B6 nano duo and your device will establish Bluetooth connection automatically.

Scan the QR code on the right to download the SkyCHARGER App.



Scan with
your **Smartphone**
to download.

OPERATION

1. Connect the power cord to B6 nano duo, then plug the power cord into the outlet (100~240V AC, 50/60Hz).
2. Connect the batteries to the corresponding channels.
3. Enable Bluetooth function on your mobile device and launch the SkyCHARGER.

1). Launch the App and set the password (Please do not set the password to 5793 which is the reserved for the system using)



CONTROLLING THE CHARGER USING THE APP

How to reset password

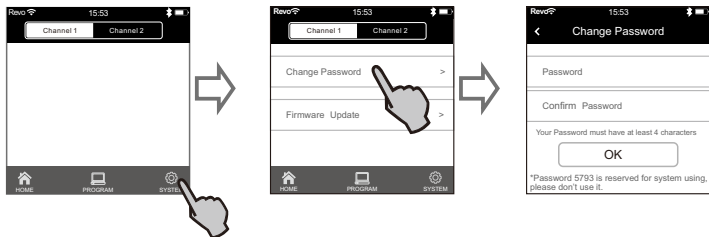

2). Operation Steps for Charging(Take 6S LiPo battery for example)

Connect the batteries to the corresponding channels, select battery type, cells. Press "NEXT" to set the proper charge current.

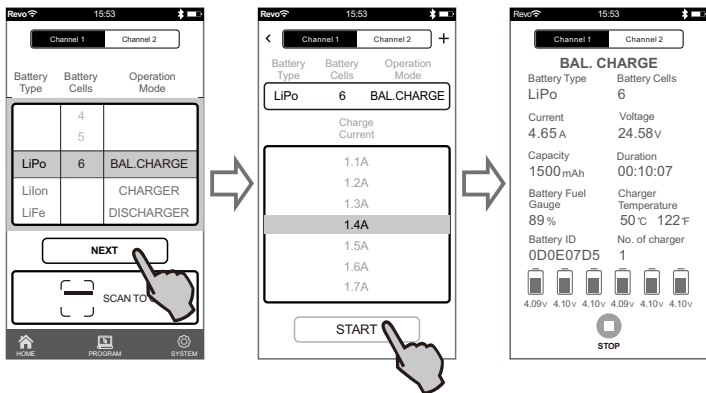

**Video
Tutorial**

Please scan and watch the tutorial video about how to control and operate the charger via smartphone.



3). How to Use Memory Program

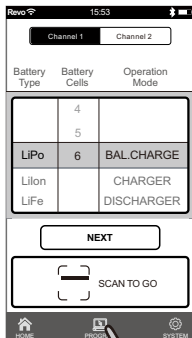

Press "PROGRAM" button

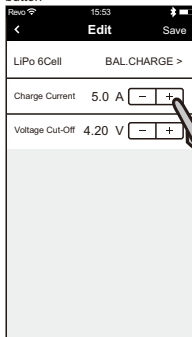

Press to save the program after set the charge current and voltage cut-off

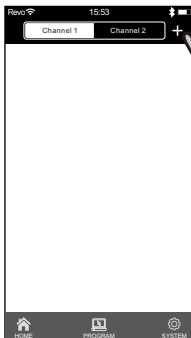

Enter into PROGRAM interface

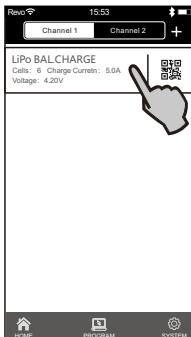

Memory program setting finishes.

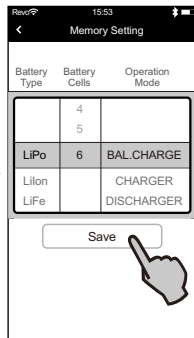

Set battery type, cells and working modes

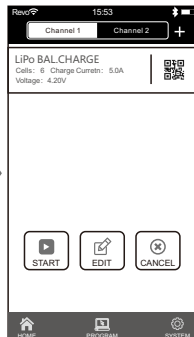

Press "START" button to start charge
Press "EDIT" button to change the setting



Video Tutorial

Please scan and watch the tutorial video about how to use memory program.



4). System Setting

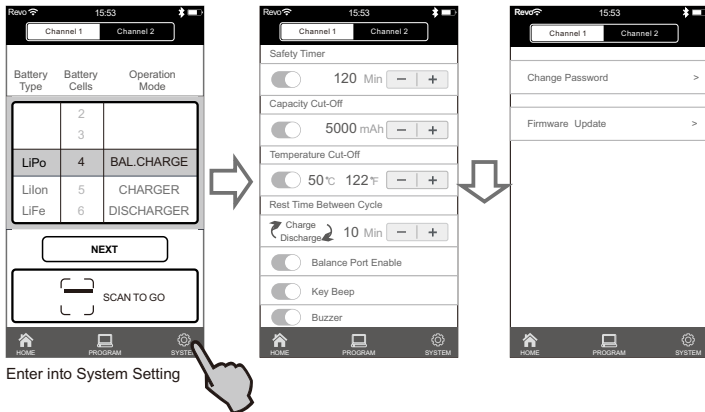

5). SCAN TO GO

A very unique feature of B6 nano duo is SCAN TO GO (automatically charging system). As the range of battery types and capacity becomes more and more, each battery requires its own dedicated charging process. It is easy to set up the charger incorrectly for a specific type of battery, resulting damage the battery or even cause accident.

The revolutionary SCAN TO GO provides a solution to this problem by allowing the user to assign a QR Code which contains all the relevant data for the battery for charging or discharging. The user can create a unique QR Code by using “SkyCharger” apps. Print it and paste it on the battery.

Using your smart phone and launch “SkyCharger” App. Since all the essential information is stored in the QR Code. All you need to do is press the Scan button, and the charge or discharge process will start automatically.

How to print QR code

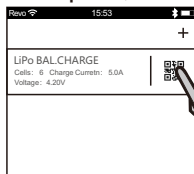

Press the QR code

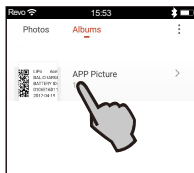

Select the QR code and open it

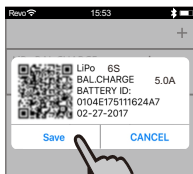

Save the QR code to Gallery

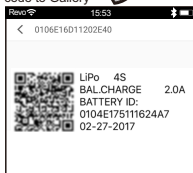

You can print it from your mobile phone or send the QR code image to computer to print it out.



Open Gallery



Attach the printed QR code to the battery

Scan to charge

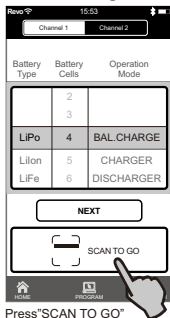

Press "SCAN TO GO"

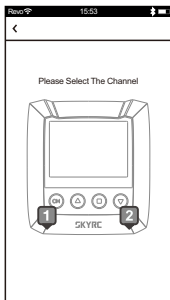

Select The Channel

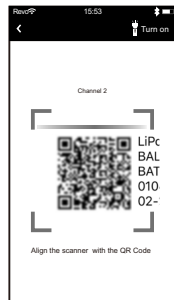

Scan to launch the program



Video Tutorial

Please scan and watch the tutorial video about how to use SCAN TO GO.



SPECIFICATION

- AC Input Voltage : 100-240V
- Display Type: LCD
- Case Material: Plastic
- Controls: Four Buttons
- Case Size: 127x115x71mm
- Weight: 561g
- External Port: 2-6S Balance Socket-XH, Battery Socket, AC Input
- Delta Peak Detection for NiMH/NiCd: 3-15mV/cell / Default: 4mV/cell
- Charge Voltage: NiMH/NiCd: Delta peak detection
 - LiPo: 4.18-4.25V/cell Lilon: 4.08-4.2V/cell
 - LiFe: 3.58-3.7V/cell LiHV: 4.25-4.35V/cell
- Balance Current: 1000mA/cell Max
- Reading Voltage Range: 0.1-26.1V/cell
- Battery Types/Cells: LiPo/Lilon/LiFe/LiHV: 1-6cells
NiMH/NiCd: 1-15cells
Pb: 2-20V
- Battery Capacity Range: NiMH/NiCd: 100-50000mAh
LiPo/Lilon/LiFe/LiHV: 100-50000mAh
Pb: 100-50000mAh
- Charge Current: 0.1A-15.0A
- Safety Timer: 1-720minutes off
- Charge Wattage: 200W(100WX2)*
- Discharge Current: 0.1A-3.0A
- Discharge Cut-off Voltage: NiMH/NiCd: 0.1-1.1V/cell
 - LiPo: 3.0-3.3V/cell Lilon: 2.9-3.2V/cell
 - LiFe: 2.6-2.9V/cell LiHV: 3.1-3.4V/cell
 - Pb: 1.8V
- Discharge Wattage: 8W
- Balance Cells: 2-6 cells
- Charge Method: CC/CV for lithium types and lead (Pb) batteries
Delta-peak Sensitivity for NiMH/NiCd.

*B6 nano duo supports power distribution when one single channel is working, the max power is 200W; when two channels are workings, it is 100W per channel.

B6 nano duo satisfy all relevant and mandatory CE directives and FCC Part 15 Subpart B: 2016.

For CE directives:

The product has been tested to meet the following technical standards:

Test Standards	Title	Result
EN 55014-1:2006+ A1:2009+A2:2011	Electromagnetic Compatibility- Requirements for household appliances, electric tools and similar apparatus- Part 1: Emission	Conform
EN 55014-2:2015	Electromagnetic Compatibility- Requirements For Household Appliances, Electric Tools And Similar Apparatus- Part 2: Immunity Product Family Standard	Conform
EN 61000-3-2:2014	Electromagnetic Compatibility (EMC) Part 3-2: Limits for harmonic current emissions(Equipment input current up to and including 16A per phase)	Conform
EN 61000-3-3:2013	Electromagnetic Compatibility (EMC) Part 3-3: Limitation of voltage supply systems for equipment with rated current $\leq 16A$	Conform
EN 300 328 V2.1.1	Wideband transmission systems; Data transmission equipment operating in the 2,4 GHz ISM band and using wide band modulation techniques; Harmonised Standard covering the essential requirements of article 3.2 of Directive 2014/53/EU	Conform
EN 301489-1 EN 301489-17	Electromagnetic compatibility and Radio spectrum Matters (ERM); ElectroMagnetic Compatibility (EMC) standard for radio equipment and services; Part 1: Common technical requirements. Part 17: Specific conditions for Broadband Data Transmission Systems.	Conform
EN 62479	Assessment of electronic and electrical equipment related to human exposure restrictions for electromagnetic fields (0 Hz - 300 Ghz).	Conform
EN 60950-1	Information Technology Equipment-Safety- Part 1: General Requirements	Conform



This symbol means that you must dispose of electrical from the General household waste when it reaches the end of its useful life. Take your charger to your local waste collection point or recycling centre. This applies to all countries of the European Union, and to other European countries with a separate waste collection system.

Commonly used terms

Final charge voltage: the voltage at which the battery's charge limit (capacity limit) is reached. The charge process switches from a high current to a low maintenance rate (trickle charge) at this point. From this point on further high current charging would cause overheating and eventual terminal damage to the pack.

Final discharge voltage: the voltage at which the battery's discharge limit is reached. The chemical composition of the batteries determines the level of this voltage. Below this voltage the battery enters the deep discharge zone. Individual cells within the pack may become reverse polarized in this condition, and this can cause permanent damage.

A, mA: unit of measurement relating to charge or discharge current. $1000 \text{ mA} = 1 \text{ A}$ (A=Ampere, mA=Milliampere)

Ah, mAh: unit of measurement for the capacity of a battery (Amperes x time unit; h = hour). If a pack is charged for one hour at a current of 2 A, it has been fed 2 Ah of energy. It receives the same quantity of charge (2 Ah) if it is charged for 4 hours at 0.5 A, or 15 minutes (=1/4 h) at 8 A.

'C'-rating: Capacity is also referred to as the 'C' rating. Some battery suppliers recommend charge and discharge currents based on the battery 'C' rating. A battery's '1C' current is the same number as the battery's rated capacity number, but noted in mA or amps. A 600mAh battery has a 1C current value of 600mA, and a 3C current value of (3 x 600mA) 1800mA or 1.8A. The 1C current value for a 3200mAh battery would be 3200mA (3.2A).

Nominal voltage(V): The nominal voltage of the battery pack can be determined as follows;

-NiCd or NiMH: multiply the total number of cells in the pack by 1.2. A 8-cell pack will have a nominal voltage of 9.6 volts (8x1.2).

-LiPo: multiply the total number of cells in the pack by 3.7. A 3-cell LiPo wired in series will have a nominal voltage of 11.1 volts (3x3.7).

-Lilo: multiply the total number of cells in the pack by 3.6. A 2-cell Lilo wired in series will have a nominal voltage of 7.2 volts (2x3.6).

-LiFe: multiply the total number of cells in the pack by 3.3. A 4-cell Lilo wired in series will have a nominal voltage of 13.2 volts (4x3.3).

If the nominal voltage of the battery is not printed on the battery's label, consult your battery manufacturer or supplier. Do not guess the rated voltage of battery.

Liability exclusion

This charger is designed and approved exclusively for use with the types of battery stated in this Instruction Manual. SkyRC accepts no liability of any kind if the charger is used for any purpose other than that stated.

We are unable to ensure that you follow the instructions supplied with the charger, and we have no control over the methods you employ for using, operating and maintaining the device. For this reason we are obliged to deny all liability for loss, damage or costs which are incurred due to the incompetent or incorrect use and operation of our products, or which are connected with such operation in any way. Unless otherwise prescribed by law, our obligation to pay compensation, regardless of the legal argument employed, is limited to the invoice value of those SkyRC products which were immediately and directly involved in the event in which the damage occurred.

Warranty and service

We guarantee this product to be free of manufacturing and assembly defects for a period of one year from the time of purchase. The warranty only applies to material or operational defects, which are present at the time of purchase. During that period, we will repair or replace free of service charge for products deemed defective due to those causes.

This warranty is not valid for any damage or subsequent damage arising as a result of misuse, modification or as a result of failure to observe the procedures outlined in this manual.

Note:

1. The warranty service is valid in China only.
2. If you need warranty service overseas, please contact your dealer in the first instance, who is responsible for processing guarantee claims overseas. Due to high shipping cost, complicated custom clearance procedures to send back to China. Please understand SkyRC can't provide warranty service to overseas end user directly.
3. If you have any questions which are not mentioned in the manual, please feel free to send email to info@skyrc.cn

This device complies with part 15 of the FCC Rules. Operation is subject to the following two conditions: (1) This device may not cause harmful interference, and (2) this device must accept any interference received, including interference that may cause undesired operation.

Note: The Grantee is not responsible for any changes or modifications not expressly approved by the party responsible for compliance. Such modifications could void the user's authority to operate the equipment.

Note: This equipment has been tested and found to comply with the limits for a Class B digital device, pursuant to part 15 of the FCC Rules. These limits are designed to provide reasonable protection against harmful interference in a residential installation. This equipment generates, uses and can radiate radio

frequency energy and, if not installed and used in accordance with the instructions, may cause harmful interference to radio communications. However, there is no

guarantee that interference will not occur in a particular installation. If this equipment does cause harmful interference to radio or television reception, which can be determined by turning the equipment off and on, the user is encouraged to try to correct the interference by one or more of the following measures:

- Reorient or relocate the receiving antenna.
- Increase the separation between the equipment and receiver.
- Connect the equipment into an outlet on a circuit different from that to which the receiver is connected.
- Consult the dealer or an experienced radio/TV technician for help.

The device has been evaluated to meet general RF exposure requirement. To maintain compliance with FCC's RF exposure guidelines, this equipment should be installed and operated with a minimum distance of 20cm between the radiator and your body.

SKYRC

Manufactured by
SKYRC TECHNOLOGY CO., LTD.
www.skyrc.com



  204-820199

FCC ID: REY-B6NANODUO

All specifications and figures are subject to change without notice.
Printed in China ©2018.08