

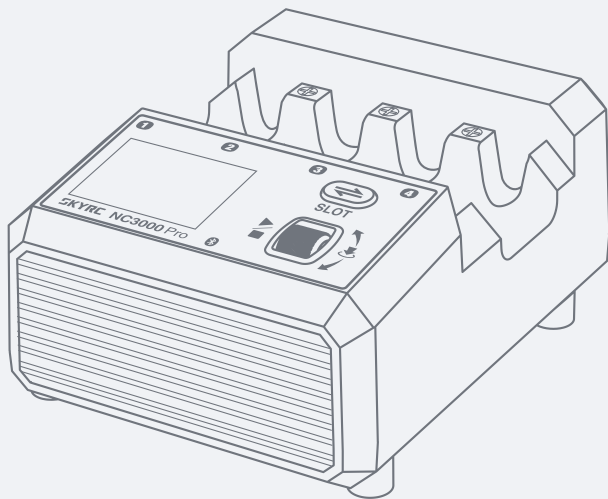

# Instruction Manual

## NC3000 Pro

AA/AAA NiMH/NiCD Battery Charger & Analyzer



# Contents

---

Introduction .....	01
Warning .....	02
Features .....	02
Specifications .....	03
Battery Knowledge .....	04
Power and Battery Connection .....	06
Charging Operation .....	07
Working Mode .....	09
Parameters Configuration .....	10
Charging Current Automatic Adjusted .....	12
Status LED Explained .....	12
Rescue Batteries .....	13
Working with the SkyCharger app .....	13
Status LED Explained .....	14
In The Box .....	14
System Settings .....	15
Conformity Declaration .....	16
Warranty and Service .....	17

# Introduction

---

## Congratulations on choosing SkyRC NC3000 Pro Charger & Analyzer!

NC3000 Pro is a versatile charger designed specifically for AA/AAA NiMH and NiCd batteries, combining charging, discharging, and analysis functions in one device. It supports QC2.0 and QC/PD3.0 inputs, and with its four independent slots, NC3000 Pro can charge up to four batteries simultaneously.

The charge and discharge currents are adjustable, with a maximum charge current of 3.00A and a discharge current of 2.50A. The color screen provides real-time data on current, voltage, and capacity at a glance.

Additionally, NC3000 Pro features built-in Bluetooth, enabling users to manage batteries and analyze data easily via the SkyCharger app.

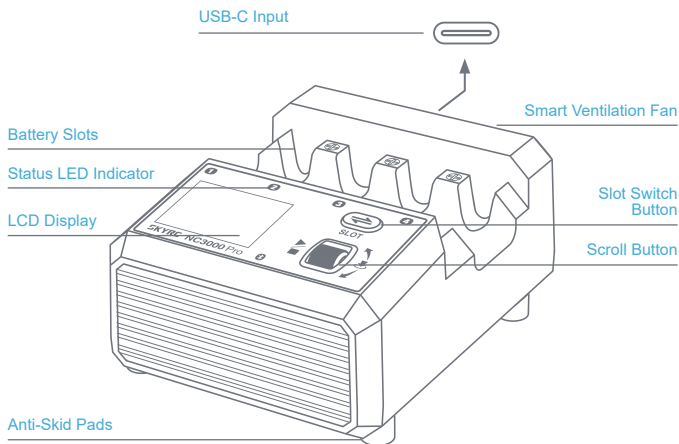

## Warning

- ⚠ Never charge batteries other than NiMH or NiCD. Please read the battery's manual to ensure it can accept the programmed charge/discharge rates.
- ⚠ Never expose the unit to rain or moisture to avoid fire.
- ⚠ Never use the charger if it appears damaged.
- ⚠ Do not place the battery with a positive terminal facing the top. Wrong polarity may cause fire or explosion.
- ⚠ Do not allow the unit to expose to direct sunlight. Operate in a well-ventilated area. Do not place the charger on the carpet.
- ⚠ Never allow the battery terminals to become shorted.
- ⚠ The batteries may become hot during charging/discharging (especially at a high current)! Please take care when removing the batteries!
- ⚠ Remove all batteries and unplug the charger from the power source when not in use.
- ⚠ Never leave the charger unattended when charging.
- ⚠ Never charge or discharge any battery having evidence of leakage, expansion/swelling, damaged outer wrapper or case, color-change or distortion.
- ⚠ Never block the cooling fan or the air ventilation holes.

## Features

---

- Supports mainstream fast charging protocols including QC2.0, QC3.0, and PD3.0, accommodating various input types.
- Four independent charging slots allow for customized charging for up to four batteries simultaneously, delivering efficient and convenient charging.
- Six charging modes: Charge, Discharge, Break-in, Cycle, MaxBoost, and Turbo to cater to different battery needs.
- Each slot supports up to 3.00A high current charging for rapid battery recovery.
- One-click synchronization of settings across all slots simplifies operation.
- Mobile app control allows you to monitor the charging status and view detailed battery data.
- MaxBoost mode unleashes the full potential of your batteries.
- Supports multiple languages, including English, German, Chinese, French, Spanish, and Japanese.
- Intuitive Scroll and Button design for easy operation.
- Color screen provides real-time display of charging data at a glance.

# Specifications

Input Power	PD, QC 30W
Quick Charge Protocol	QC2.0, QC3.0, PD3.0
Battery Type	NiMH/NiCD
Battery Size	AA/AAA
Charge Power	Max. 22W
Discharge Power	Max. 15W
Charge Rate	0.20-3.00A w/ increments of 0.10A
Discharge Rate	0.20-2.50A w/ increments of 0.10A
Trickle Charge Rate	10-300mA & OFF
Target Volt.	1.47-1.80V
Discharge Cut-Off Volt.	0.50-1.10V
Supported Capacity	100-5000mAh
-ΔV	1-20mV
Working Environment	Temperature: 0°C/32°F ~ 40°C/104°F Humidity: 5% ~ 75%
Storage Environment	Temperature: -10°C/14°F ~ 70°C/158°F Humidity: 5% ~ 75%
Weight	Approx. 380g
Size	134*105*61 mm



# Battery Knowledge

## What is the Meaning of “mAh” on Rechargeable Batteries?

**mAh** stands for milliamp hour, a unit that measures electric power over time. It is commonly used to indicate a battery's energy capacity. Generally, a higher mAh value means greater battery capacity and longer battery life.

Battery Capacity **mAh** (milliampere/hour) = discharge (milliampere) x discharging time (hour)

For example, if you insert 2400mAh battery into an appliance which consumes 50 milliampere current continuously, the operating time of the appliance will be around 48 hours.

## What is "C" Charge/Discharge Rate

The battery "C" Rating is the measurement of current at which a battery is charged or discharged. "C" stands for the battery capacity, and the number preceding it is the fraction of the battery capacity. For example, 0.3C means 0.3 times the capacity for the battery. For a 2400mAh battery, 0.3C would be  $0.3 \times 2400\text{mAh} = 720\text{mA}$ .

## Choose the Right Charge & Discharge Rate

It is not recommended to charge at a rate lower than 0.3C and higher than 1.0C. Charging too slow may affect the charger termination properly. Charging too fast may cause the battery to overheat, and shorten its lifespan.

Generally speaking, a smaller charging rate can prolong the battery lifespan while charging time will be longer. A larger charging rate makes charging fast but with the battery heat-up, which will shorten its lifespan.

It is not recommended to use a discharge rate above 1.0C.

Charge/Discharge Rate Reference

AAA Batteries

Battery Capacity(mAh)	Charge Rate(mA)	Discharge Rate(mA)
700	300	100
800	400	200
900	400	200
1000	500	200
1100	500	200
1200	600	300



# Battery Knowledge

## AA Batteries

Battery Capacity(mAh)	Charge Rate(mA)	Discharge Rate(mA)
1800	1800	400
2200	2000	500
2400	2000	600
2600	2000	600
2700	2000	600
1200	600	300

## Battery Matching

Most electronic devices require two or more batteries to operate together. In such cases, the overall power performance is limited by the weakest battery.

In other words, a poorly performing battery will reduce the device's operating time. Battery matching involves grouping batteries with similar capacities to ensure balanced performance.

Grouping batteries by capacity maximizes efficiency. With **Cycle mode**, you can easily match batteries with similar capacities!

## Battery Formatting

New batteries and those stored for more than three months become chemically deactivated. The battery formatting refers to activating the battery with a small charge and discharge rate. This can be achieved through the Break-in mode. In some circumstances, this process may need to be repeated two to three times.

# Power and Battery Connection

1. Connect to a PD/QC 30W or higher power adapter, ensuring the input power complies with QC2.0, QC3.0, and PD3.0 input standards.

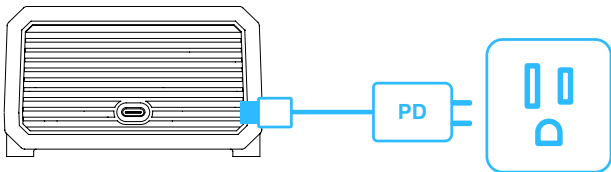

2. Insert AA or AAA batteries.

*Note: Always insert the Negative(-) terminal FIRST as shown in the diagram.*

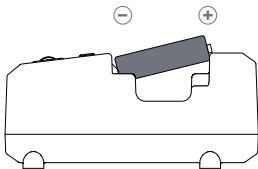

**Insert AA batteries**

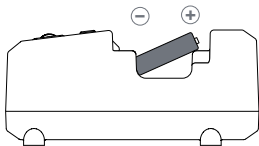

**Insert AAA batteries**

# Charging Operation



Scan or Click to Watch

1	1.26V	0.00 A	0 mAh
2	1.26V	0.00 A	0 mAh
3	1.26V	0.00 A	0 mAh
4	1.26V	0.00 A	0 mAh

## Select Charge Slot

Press PORT and Scroll Button to select the charge slot.

1 Charge setting	
Mode	Charge
Capacity	2000 mAh
C. Current	1.00 A
Target Volt	1.65 V

## Enter Charge Setting

Press Scroll Button to enter Charge Settings.

1 Charge setting	
Mode	Charge
Capacity	Discharge
C. Current	Break_in
Target Volt	Cycle

## Select Mode

Press and scroll to select your desired working mode.

1 Charge setting	
Mode	2000mAh
Capacity	2100mAh
C. Current	2200mAh
Target Volt	2300mAh

## Select Capacity

Press and scroll to select the capacity.

1 Charge setting	
Mode	1.00A
Capacity	1.10A
C. Current	1.20A
Target Volt	1.30A

## Select Charge Current

Press and scroll to select the preferred charge current.

1 Charge setting	
Mode	1.65V
Capacity	1.66V
C. Current	1.67V
Target Volt	1.68V

## Select Target Voltage

Press and scroll to select the cut-off voltage.

1 Charge setting	
Timer Cut-Off	180min
Restart Volt	190min
- ΔV	200min
Trickle Charge	210min

## Select Cut-off Timer

Press and scroll to select the safety timer.

1 Charge setting	
Timer Cut-Off	1.35V
Restart Volt	1.36V
- ΔV	1.37V
Trickle Charge	1.38V

## Select Restart Voltage

Press and scroll to select the restart voltage.

1 Charge setting	
Timer Cut-Off	3mV
Restart Volt	4mV
- ΔV	5mV
Trickle Charge	6mV

## Select -ΔV

Press and scroll to select the -ΔV accordingly based on the battery.

# Charging Operation



Scan or Click to Watch

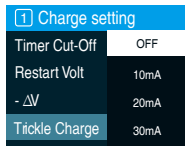

## Select Trickle Charge Current

Press and scroll to select the trickle charge current.

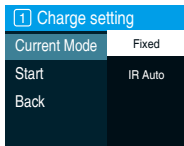

## Select Current Mode

Press and scroll to select the preferred current mode.

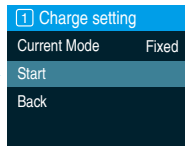

## Start

Press Scroll Button to initiate the program.

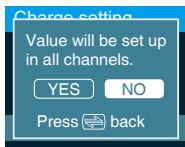

## Value will be set up in all channels

Confirm if apply the charge settings to all channels.

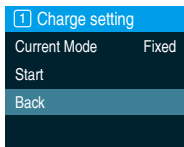

## Back

Press Scroll Button to back to the main interface.

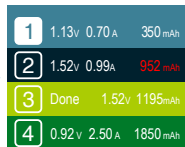

## Stop

Press Scroll Button to terminate the current program.

# Working Mode

---

This charger provides up to six charging modes of **Charge, Discharge, Break-in, Cycle, MaxBoost, and Turbo**, fully meeting the charging requirements of different batteries.

## Charge

Applicable for charging the batteries in a good performance and continuous use. The charging process terminates when the battery is full or some other termination criteria have been met.

## Discharge

Applicable for discharging the batteries in a good performance and continuous use. The discharging process terminates when the discharge or some other termination criteria have been met.

## Cycle

This mode is used to determine the battery's performance based on the actual capacity it can hold. It's applicable for batteries stored for more than two weeks and less than three months, or for batteries that are not performing well. The capacity of each cycle can be viewed once the cycle process is finished.

## Break-in

Applicable for new batteries, those stored for more than three months, and batteries that cannot be rescued through Cycle mode. The Break-in mode is to activate the battery with a small charge and discharge rate in a C->D->C and D->C->D sequence. For example, C->D->C mode will charge the batteries at 0.1C(0.1\*battery capacity) for 16 hours and rest for some time(the time can be selected). Then, fully discharge the batteries at 0.2C and rest for some time again. Finally, charge the batteries at 0.1C for 16 hours again. In some circumstances, this process may need to be repeated two to three times.

## MaxBoost

This mode is specifically designed for racing that requires peak performance for the batteries. It will fully charge the battery, then discharge it to a specified capacity based on your settings. Before racing, use the Charge mode to fully charge the battery, ensuring optimal performance.

## Turbo

This mode enables to charge four batteries at charge rate up to 3.00A simultaneously, making the charging more effective.

*Note: This mode assumes batteries must perform very well. The charger will measure the battery resistance and adjust the charge current automatically if the Current Mode > IR Auto is selected under Turbo working mode. If the battery resistance is more than 40mΩ, the charger will stop working with an error to protect the battery.*

# Parameters Configuration

---

## Capacity

This capacity serves both as the battery's rated capacity and as a protective setting. In Break-in mode, this option is labeled as rated capacity and the user is required to select the rated capacity of the battery. In other working modes, this option is to protect the battery. For example, select 4200mAh for a 20% buffer on a 3500mAh rated battery. The cut-off capacity is to prevent overcharging or overdischarging, especially for batteries with unknown performance or capacity.

## C. Current

Applicable for Charge mode and other working modes which include at least 1 charging routine. In Break-in mode, this is fixed at 0.1C and cannot be set.

## D. Current

Applicable for Discharge mode and other working modes which include at least 1 discharging routine. In Break-in mode, this is fixed at 0.2C and cannot be set.

## Target Volt.

The charge program terminates when the battery voltage reaches the preset target voltage.

## D. Cut-off Volt.

The discharge program terminates when the battery voltage reaches the preset discharge cut-off voltage.

## D. Cut-off Curr.

When reaching discharge cut-off voltage, this option will hold that voltage constant while automatically reducing the current down to the set value before it terminates the discharging routine. Setting this option will extend the discharging period, but it can effectively reduce the extent of voltage recovery once discharging is complete.

## Cut-off Timer

The charger will terminate the program with error when the working time of the program reaches the cut-off timer settings. This is to protect the battery from overcharging or overdischarging.

## Restart Volt.

Applicable for Charge mode, when charging has finished, the voltage of bad-health batteries is prone to decline rather fast due to selfdischarging. Setting this value lower than target voltage will guarantee a minimum battery voltage when removing the battery. Naturally, one cannot set it higher than the target voltage parameter.

# Parameters Configuration

---

## -ΔV

A technical parameter to control charge termination of NiMH/NiCd batteries. When charging a battery at constant current, the voltage will be decreased slightly around full charge completion. By monitoring this voltage drop, the charger can accurately detect if the batteries are fully charged or not. Users can set a reasonable negative delta voltage based on the battery condition to prevent from overcharging and extend the battery life span.

## Trickle Charge

A small current typically applied after a charge program has finished to counter the effects of self-discharge, it helps to keep the batteries topped off.

## Current Mode

This mode gives users the flexibility to choose their desired operating mode of the charge current. It only applies to the Turbo, Cycle, MaxBoost, and Charge mode. When Fixed is selected, the charger will output according to the set charge current. When IR Auto is selected, the charge current will be automatically decreased based on the batteries' internal resistance. Users can refer to the charge current adjustment in [P12](#).

## Resting After C.

Defines the duration of the resting phase subsequent to the cycle charge routine. It can be set between 0 and 240 minutes. The battery can cool down and rest during this period.

## Resting After D.

Defines the duration of the resting phase subsequent to the cycle discharge routine. It can be set between 0 and 240 minutes. The battery can cool down and rest during this period.

## Cycle Count

It refers to the number of cycles under Cycle mode. Users can select the suitable cycle count according to the battery condition, the count can be set from once to three times.

## Cycle/Break-in

A so-called Cycle and Break-in can be defined as sequence of at least one charging and one discharging routine, or vice versa. "D->C->D", for example, will start with an initial discharge before performing a complete charge followed by a complete discharge.

## D. Capacity

This option only applies to MaxBoost mode. It will fully charge the battery, then discharge it to a specified capacity based on your settings. Before racing, use the Charge mode to fully charge the battery, ensuring optimal performance.

# Charging Current Automatic Adjusted

The internal resistance of the battery usually increases as it is used. When the battery is used for a long time, its internal resistance will increase. The internal resistance consumes part of the electric energy when charging and causes the battery to heat up at the same time.

The charger supports battery internal resistance detection. When IR Auto is selected under Current Mode and a high internal resistance is detected, the charge current will be automatically decreased to reduce the overall heating and protect the battery. When Fixed is selected, the charger will output according to the set charge current.

## Note:

Please use the Cycle mode when determining the battery capacity.

Battery Internal Resistance	Charge Rate
Great than 20mΩ while less than or equal to 40mΩ	Limit to 1.5A
Great than 40mΩ	Turbo charge stops
Great than 40mΩ while less than or equal to 60mΩ	Limit to 800mA
Great than 60mΩ	Limit to 400mA

# Status LED Explained

LED Status	Explanation
Off	No battery inserted
Solid yellow	Standby or rest with battery inserted
Blinking green	Charging
Blinking red	Discharging
Solid green	Charging complete
Solid red	Discharging complete
Blinking red&green alternately	Error

# Rescue Batteries

If the batteries are still not performing well after trying all the modes as in the manual, refer to the battery rescue steps below:

1. Use the Cycle mode once to three times.
2. Change to Break-in mode if the capacity is still low.
3. If the second steps can improve the battery capacity by more than 10%, please try Break-in mode once to three times again. If there are no significant improvements and the actual battery capacity is less than 60% of its rated capacity. The battery would probably be at the end of its life and needs to be replaced.

## Working with the SkyCharger App

With the built-in Bluetooth 5.0, users can control the charger, view the charging graph and upgrade the firmware via the SkyCharger app.

### Operation

1. Connect the charger to a PD/QC 30W or higher power adaptor.
2. Insert AA or AAA batteries.
3. Press + to add a device, and verify the Bluetooth ID before selecting the device.
4. Set the passcode, select the slot, and configure the parameters.
5. Select whether to apply the charge settings to all slots.
6. Click **START** to initiate charging
7. Click **Details** to view the charging graph and operation details, click the battery icon to switch the view between slots.
8. Click the slot number button to stop the program operation of in that slot.



[Scan or Click to Watch](#)



### SkyCharger App



### Please be reminded:

1. Ensure your phone's Bluetooth is enabled, then launch the SkyCharger app to search for and connect to the charger.
2. DO NOT connect the charger through your phone's Settings > Bluetooth!

# Errors Explained

In case of a fault, NC3000 Pro will display an error message as shown in the table below, which users can refer to for troubleshooting guidance.

Error Message	Explanation
DC In Too Low!	The input voltage is lower than 4.7V!
DC In Too High!	The input voltage is higher than 22V!
Connection Break!	The battery connection may be broken!
Capacity Limit Reached!	The charged capacity reaches the preset capacity limit!
Time's Up!	The program has timed out!
Calibration Failed!	Batteries in poor condition or with high internal resistance may be rejected.
High Internal Resistance!	The charging stops if the battery IR is more than 40mΩ under Turbo mode.

## In The Box

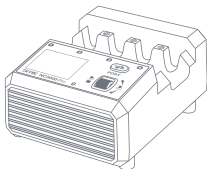

1\*SkyRC NC3000 Pro Charger

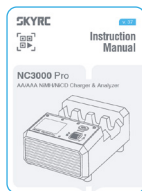

1\*Instruction Manual

# System Settings

---

Press and hold the Scroll button to enter System Settings.

Option	Definition
Language	Select your preferred language
LCD Backlight	Adjust the screen brightness.
Key Press Beep	Adjust the key volume
Notif. Beep	Adjust the error and completion beep volume
Completion Beep	Choose how you'd like to be notified when the program is complete. If Repeat is selected, a completion beep will sound again after 30 minutes.
User Guide	Scan the QR code to view the manual. Press the Scroll Button to exit.
System Info.	Check the current system information. Press the Scroll Button to exit.
Regulatory	Check the regulatory information. Press the Scroll Button to exit.
Factory Reset	Restore to the factory settings.
Back	Back to the previous interface.

# Conformity Declaration

---

SkyRC NC3000 Pro complies all the relevant and mandatory CE directives and FCC Part 15 Subpart B.

# Liability Exclusion

---

This charger is designed and approved exclusively for use with the types of battery stated in this Instruction Manual. SkyRC accepts no liability of any kind if the charger is used for any purpose other than that stated. We are unable to ensure that you follow the instructions supplied with the charger, and we have no control over the methods you employ for using, operating, and maintaining the device.

For this reason, we are obliged to deny all liability for loss, damage, or costs that are incurred due to the incompetent or incorrect use and operation of our products, or which are connected with such operation in any way. Unless otherwise prescribed by law, our obligation to pay compensation, regardless of the legal argument employed, is limited to the invoice value of those SkyRC products which were immediately and directly involved in the event in which the damage occurred.

# Warranty and Service

---

We guarantee this product to be free of manufacturing and assembly defects for a period of one year from the time of purchase. The warranty only applies to material or operational defects, which are present at the time of purchase. During that period, we will repair or replace free of service charge for products deemed defective due to those causes.

This warranty is not valid for any damage or subsequent damage arising as a result of misuse, modification, or as a result of failure to observe the procedures outlined in this manual.

## Note:

1. The warranty service is valid in China only.
2. If you need warranty service overseas, please contact your dealer in the first instance, who is responsible for processing guarantee claims overseas. Due to high shipping costs, and complicated custom clearance procedures to send back to China, please understand that SkyRC can't provide warranty service to overseas end users directly.
3. If you have any questions which are not mentioned in the manual, please feel free to send an email to [info@skyrc.com](mailto:info@skyrc.com)

# SKYRC

The content is subject to change without notice;  
please refer to our website for the latest version!



<https://www.skyrc.com>

If you have any questions about this document, please contact  
SkyRC by sending a message to **support@skyrc.com**

SKYRC ® is a trademark of SkyRC Technology Co., Ltd.

© 2026 SkyRC Technology Co., Ltd.